

EXTRACTOR DE AIRE ASPA METÁLICA 8"



EXTRACTOR

VOLTAJE
110-130 Vol 50/60Hz
RPM
1.450
AMPERIOS
0.65A
MOTOR
8W

VATIOS
30W
CAUDAL
0.36m³/seg
CAMPANA EXTRACTORA
8"(200mm)

Nuestra línea de campanas extractoras con aspa metálica también tiene uso doméstico. Viene sin rejilla y está diseñado para incrustar en los muros.

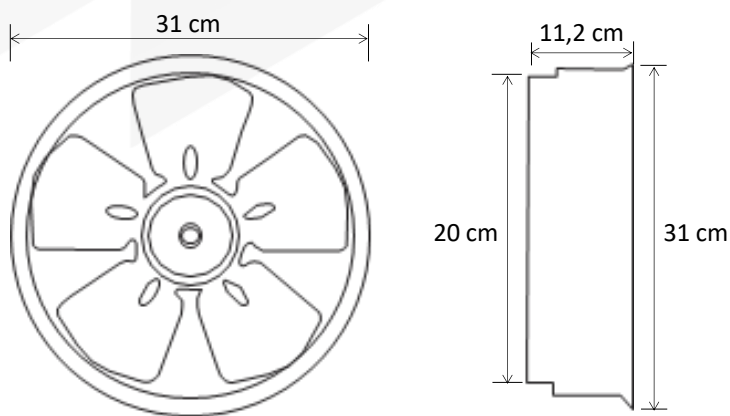

APLICACIÓN



OFICINAS
Offices



HOGARES
Homes



CENTROS
COMERCIALES
Mall



ESTACIONES
Gas station



HOSPITALES
Hospital



C. EDUCATIVO
Educational