

EXTRACTOR DE AIRE ASPA PLÁSTICA

16"



EXTRACTOR

Voltaje
110-130v
Frecuencia
50-60 Hz
Amperaje
1.695A
RPM (Balinera)
1.600
Caudal
1.70m3/seg

Factor de potencia
0.9
Medidas
52 x 40 x 15.3 cm
HP
1/6
Aspas
Plásticas
Uso
Industrial
Material
Metal

Nuestra línea de campanas extractoras con aspa plástica también tiene uso industrial. Viene sin rejilla y está diseñado para incrustar en los muros.

APLICACIÓN

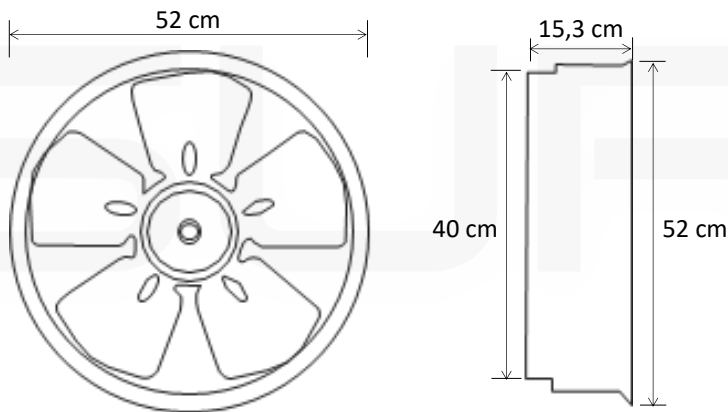

INDUSTRIAS
Factories



GRANDES
SUPERFICIES
Supermarket



PARQUEADEROS
Parking lot



ESTACIONES
Gas station



HOSPITALES
Hospital



C. EDUCATIVO
Educational